

OrienTek All-new T45 Optical Fiber Fusion Splicer

User's Manual

Safety Summary

The following general safety precautions must be observed during all phases of operation of this instrument. Failure to comply with these precautions or with specific warnings elsewhere in this manual violates safety standards of design, manufacture, and intended use of the instrument. Our company assumes no liability for the customer's failure to comply with these requirements.

ENVIRONMENTAL CONDITIONS

Refer to the specifications in chapter 3 for operating and storage environment.

BEFORE APPLYING POWER

Refer to the specifications for the voltage in chapter 3. Verify that the product is set to match the available voltage, and all safety precautions are taken.

DO NOT OPERATE IN EXPLOSIVE ATMOSPHERE

Do not operate the instrument in the presence of flammable gases or fumes.

DO NOT REMOVE THE INSTRUMENT COVER

Operating personnel must not remove instrument covers, other than as explained in this guide. Component replacement and internal adjustments must be made only by qualified service personnel.

General Safety Information

➤ **AC/DC Adapter/Charger**

The following voltage requirements must be met: 12.9V to 14V, 4.5A, positive core. Use of higher voltages may damage the product. The adapter accepts from 100V to 240V, 50Hz to 60Hz.

➤ **Battery**

1. Use lithium battery. Use of other batteries may damage the product and compromise the user's safety.
- 2.. Do not short circuit the battery by directly connecting the metal terminals. Be certain that no metal objects such as coins, paper clips and so on touch the terminals.

➤ **Operation of fiber fusion splicer**

1. When the following situation happened, please turn off the instrument and cut off the power, otherwise the instrument would be damaged.
 - ◆ Liquid or eye-winker entered the instrument.
 - ◆ Instrument was impacted strongly.
2. There are no parts which need maintenance, don't disassembly the instrument.

Caution

➤ **AC/DC Adapter/Charger**

Please use the AC/DC adapter/charger that supplied by our company. Use of another type of AC/DC adapter can damage the instrument.

➤ **Battery**

1. If your battery is new or has been in storage for a long time, you may need to charge it two or three times to achieve optimum performance levels.
2. For the best battery performance and accuracy of the fuel gauge, completely discharge the battery, then make a complete fast charge cycle (non-operating), and completely discharge the battery again.
3. You must ensure that the charging cycle is not interrupted by a battery discharge, and the discharge cycle is not interrupted by battery charging.
4. Storage temperature range (the storage time is longer than six months) is: -20°C to 45°C . Storage temperature range(the storage time is shorter than or up to six months) is : -20°C to 60°C .
5. To insure safe charging, the temperature should keep $0^{\circ}\text{C} \sim 40^{\circ}\text{C}$ inside the OFFS. If the temperature is exceeded, the charging would be stopped.

➤ **LCD**

1. Don't use any sharp device to press the touch screen.
2. Don't pollute touch screen with any organic compound or organic contaminant such as heptanes, ethanol, toluene, cello solve acetate, hydrochloric acid, motor oil, diesel fuel etc.
3. Clean the touch screen with a soft, non-abrasive cloth dampened with glass cleaner.

➤ **Fiber Fusion Splice Use Caution**

1. This OFFS can only fusion splice quartz fiber, please don't apply it to other type fibers.
2. Please keep the shield closed in most time in dusty air to avoid massing dust.
3. When you move to environment of high temperature, please avoid condensing.
4. Annual maintenance is suggested to keep the performance.
5. The OFFS is fine calibrated instrument, please avoid vibration and impact.

Maintenance and Warranty

Our company warrants this instrument against defects in material and workmanship for 18 months, battery for 3 months from the date of original shipment. From the date of original shipment. The warranty can become null and void if:

1. The instrument has been misused, neglected, or damaged by accident.
2. The instrument has discharged more than 3000 times. The instrument has been tampered with, repaired, or worked upon by unauthorized individuals.
3. Case screws or seals, other than those specified in this guide, have been removed.

If the instrument must be returned to our company, Please pack the equipment in its original shipping material, be sure to write a tag showing owner, return address, telephone and the type of service required. If you do not have the original shipping box, you must use an appropriate shock absorbing material, otherwise the instrument can be damaged, and the warranty can become null and void.

Our company reserves the right to make changes in the design or construction of any of its products at any time without incurring any obligation to make changes whatsoever on units purchased. Accessories, including but not limited to fuses, pilot lamps and batteries used with this product are not covered by this warranty.

Contents

Safety Summary	i
General Safety Information	ii
Caution	iii
Maintenance and Warranty	v
Contents	vi
Chapter 1 General Information	1
Chapter 2 Special Terms	2
Chapter 3 Technical Parameters	5
Chapter 4 Configuration	7
Chapter 5 Structure and Panel	8
Chapter 6 Installation and Adjustment	14
Chapter 7 Basic Operation	16
Chapter 8 Maintenance	27
APPENDIX A Test and Adjustment	31
APPENDIX B Heat Time Adjustment	36
APPENDIX C Setup	37
APPENDIX D Maintenance	41
APPENDIX E The Parameters of MMF Adjust	44
APPENDIX F Exchange of Electrodes	45
APPENDIX G System Update	46
APPENDIX H Fiber Cleaver	47

Chapter 1 General Information

The Optical Fiber Fusion Splicer (OFFS) is applied to fiber fusion splice, it can splice various types of optical fiber (core diameter:80-150 μ m) including single mode fiber, multi-mode fiber, dispersion shifted fiber. OFFS which is a fine product based on optical-mechanical-electrical integration should be keep clear, and the impact and vibration should be avoided.

Chapter 2 Special Terms

2.1 SM

Single Mode Fiber

2.2 MM

Multimode Fiber

2.3 DSM

Dispersion Shifted Fiber

2.4 NZDSM

Non-zero Dispersion Shifted Fiber

2.5 Cleave Length

The prepared fiber as figure 2-1, refers to the bare fiber length after cleaving. The typical value is 10mm~16mm.

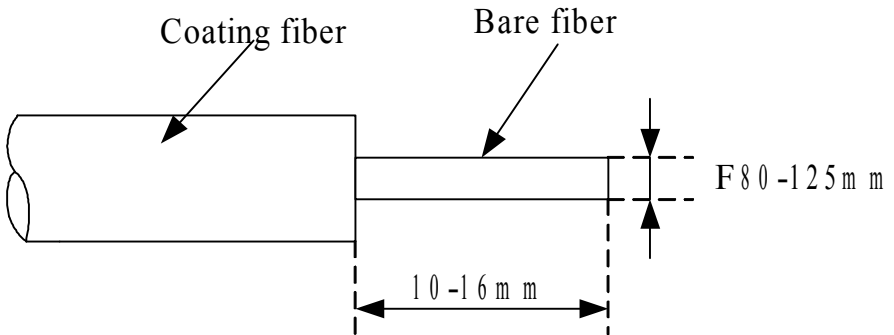

Figure 2-1

2.6 Bare fiber

The Optical Fiber whose coat is removed is called Bare Fiber.

2.7 Picture

The image of fibers on screen is as figure 2-2 and figure 2-3, the position of the two fibers is displayed by two image of fiber

in vertical direction signed by 'X' and 'Y'. The text on the top of the screen is the index of used fusion parameter group.

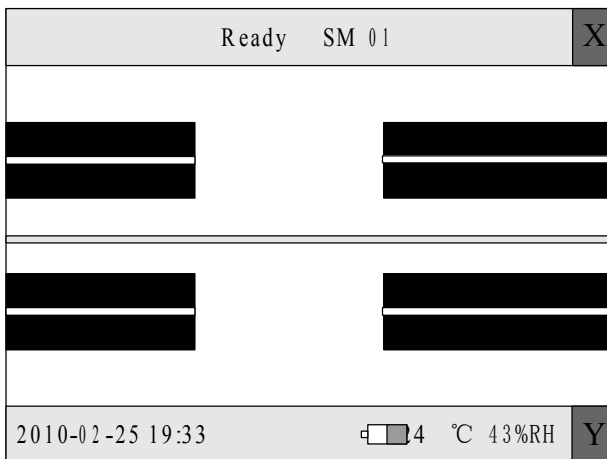

Figure 2-2

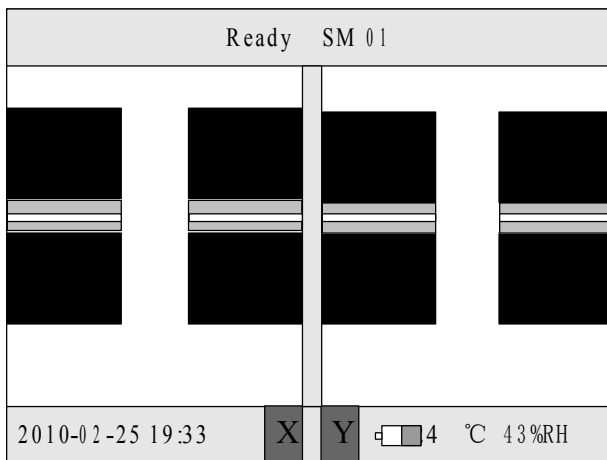

Figure 2-3

2.8 RESET

The operation makes the internal execution parts and circuit

parameters return to their initial status. Once reset, the Splicer is capable of splicing again.

2.9 Alignment

The operation is to adjust the two fibers, so that they are in the same direction. If they are not properly aligned, there will be deviations in the horizontal (x-axis) and vertical (y-axis) directions, which are called radial offset. The alignment operation controls the radial offset within the allowable range.

2.10 Estimated Splice Loss

The splicer calculates the loss at the splicing point according to the fiber images. The results are reliable when the splicing is done correctly.

2.11 Fiber Protection Sleeve

Used to protect the splicing point, as shown in the following figure.

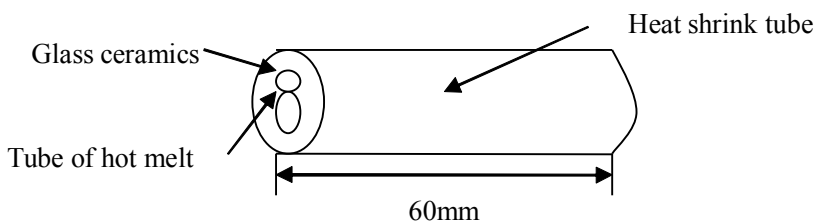

Figure 2-3

Chapter 3 Technical Parameters

3.1 Fiber Requirements

The OFFS can splice the fibers which accord with ITU-TG.651 ~ G.655, the other quartz fiber on the following condition can be spliced, but the index can't be assured.

- Fiber material: Silica glass
- Fiber number: Single
- Fiber type: SM, MM, DS, NZDS
- Cleave length: 10mm ~ 16mm
- Cladding diameter: 80 μ m ~ 150 μ m
- Coat diameter: 100 μ m ~ 1000 μ m

3.2 Fiber Heater

- Effective heating length: <60mm
- Heating time: 10 ~ 90s, 9 options available
- Typical heating time: 30s

3.3 Power Supply

- DC input: 13.5 \pm 0.5V, 4.5A. The middle electrical outlet is anode.
- Embedded Li-Ion battery: 11.1V 10.4Ah. Charging time is about 3.5 hours.

3.4 Size and Weight

- Size: 160mm(L) \times 140mm(W) \times 150mm(H)
- Weight: 2.8kg

3.5 Environmental Conditions

- Operating temperature: 0 $^{\circ}$ C \sim +40 $^{\circ}$ C

- Temperature limits: $-10^{\circ}\text{C}\sim+50^{\circ}\text{C}$
- Operating humidity: $<95\%\text{RH}$ (no condensing)
- Windy speed: $<15\text{m/s}$
- Storage temperature: $-20^{\circ}\text{C}\sim+60^{\circ}\text{C}$
- Storage humidity: no condensing

3.6 Splice Loss

For those fibers recommended by ITU-T G.651 ~ G.655, the reference splice losses are as follows:

- SM: 0.02dB
- MM: 0.01dB
- DSF: 0.04dB
- NZDSF: 0.04dB

3.7 The others

- Typical fusing time: 8s
- Image processing mode: digital
- Electrical Pole life-time: 2500 times
- Tension test: 2N
- 5.7 inch TFT colorful LCD
- USB port, through which software can be updated and the splicing data was exported.
- VGA port
- Real-time display of battery capacity
- Embed High light LED, convenience was provided to night work.

Chapter 4 Configuration

The standard configuration of the OFFS as following table.

Table 4-1

NO	Name	Picture	QTY	Remark
1	Optical Fiber Fusion splicer		1	Host
2	Carrying case		1	Accessory
3	Pump bottle		1	Accessory
4	Blower brush		1	Accessory
5	AC current cable		1	Accessory
6	AC power adapter		1	Accessory
7	Spare electrodes		1	Accessory
8	Cooling tray		1	Accessory
9	T30C Fiber Cleaver		1	Accessory
10	Miler Stripper		1	Accessory

Chapter 5 Structure and Panel

5.1 Brief introduction of Structure

The portable fusion splicer which was specially designed is suitable for field, lab and other situations. The Jig and Fixture is as Figure 5-1.

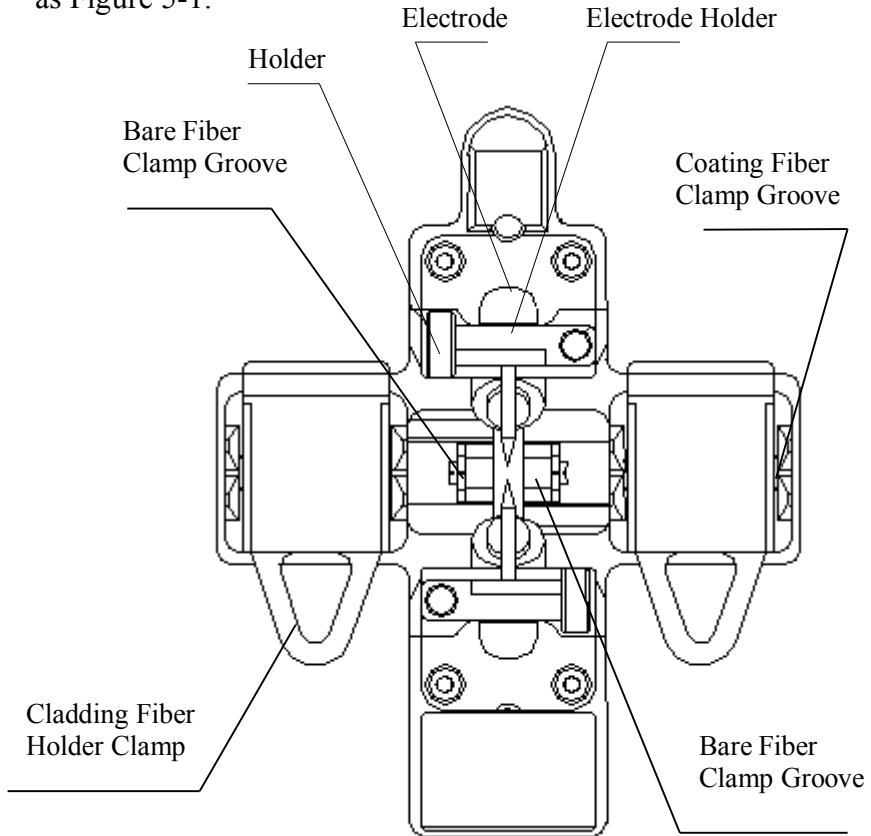

Figure 5-1

5.2 Introduction to Panel

5.2.1 Shield

The shield is closed unless fibers are going to be put in. Close it before any keyboard operation. With a viewfinder mirror and a holding clamp for bare fiber in the V-groove, it can prevent dust and wind and provide vertical light for the microscope.

5.2.2 Screen

The viewing angle of the 5.7-inch TFT-LCD can be adjusted. But please protect its screen from hard sharp things!



5.2.3 Power Supply

To provide convenience for user, the inner Li-Ion battery and direct current was applied. The direct current was supplied by the adapter, and the battery was charged when the adapter was used.

5.2.4 Charging Indicator Light

When the adapter was plugged in, the red indicator LED was turned on. The green led will shine after charging was accomplished.

5.3 Introduction to Keyboard

The layout of the keyboard as figure 5-2. There are two kinds of key operation, i.e. Menu and Fusion.  ,  and  are effective in any mode, the function are listed in table 5-1. Under Menu and Splice mode, the function of key are listed in table 5-2, table 5-3.

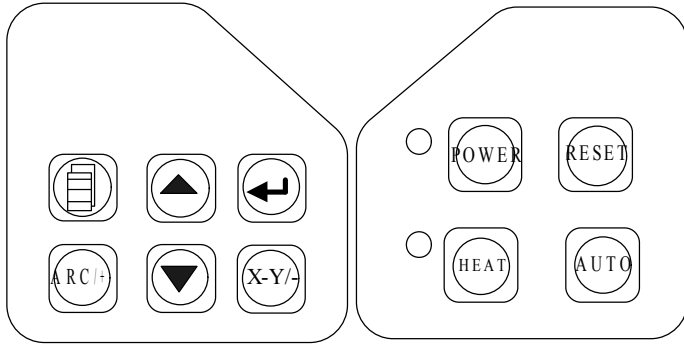

Figure 5-2

Table 5-1



Key	Function Description
	<p>This key is power, when it was pressed for about 0.5 second; the instrument would turn on or turned off.</p>
	<p>Press to operate the reinforcement heater. The red lamp is lit during operation. And if the cover is covered, the heater will work also. The heating time can be set in the menu, the operation refer to APPENDIX B. If the key is pressed in the heating procedure, the heater will stop heating.</p>
	<p>All operations except heating would be canceled, if this key was pressed, and all the motional parts will be move to default position, and the instrument is ready for next fusion.</p>

Table 5-2







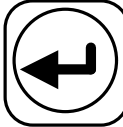

Key	Function Description
	<p>Exit the current menu and return to the upper level or to the splicing interface (if in the main menu currently).</p>
	<p>Press to enter the next sub-level menu ; used to switch between the right and left fibers when adjusting motor, In the test menu, it confirms the start of a test.</p>
	<p>Move the cursor up or increase a parameter. In motor test menu, used to move the fiber up.</p>
	<p>Move the cursor down or reduce a parameter. In motor test menu, used to move the fiber down.</p>
	<p>If the menu was pressed in menu, the parameter value would be decreased, or the screen will be changed.</p>
	<p>If the key was pressed in menu, the parameter value would be increased.</p>

Table 5-3

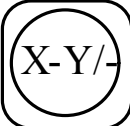
Key	Function Description
	<p>Press this key; the splicer accomplishes cleaning, gap adjustment, alignment, fusion splicing and loss estimating functions. The results will be displayed automatically on the screen.</p>
	<p>Press this key and the splicer will discharge for a short time between the two electrodes. This operation can get rid of the dust on the fiber but not of the stabs on the fiber NZDS.</p>
	<p>Press this key and one round of fusion splice will be done. The estimated loss will be displayed on the screen. Do not press this key without fiber, except for cleaning the electrodes. During discharge there is thousand NZDS of voltage between the electrodes. So for safety, don't touch them.</p>
	<p>Press this key and the splicer will adjust the fiber to an appropriate position and clean it for fusion. When the operation is done, the buzzer beeps and the screen display "OK".</p>
	<p>Press this key, alignment will be done. When alignment is done, the buzzer beeps and the screen display "OK".</p>
	<p>Press this key to enter the main menu.</p>

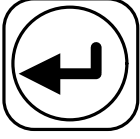
5.4 Introduction to Port board

Input/Output port is on the right side of the main body, as figure 5-3, the function are introduced in table 5-4.

Table 5-4

Name	Function Description
POWER IN	DC power input terminal, 14.5V, 45A.
CHARGE	When the lamp is red, the battery is charging. When the lamp is off, the battery is full.
USB	Used to upgrading software and exporting record data.
VGA	Video signal output.

5.5 Introduction to Standby Interface

The standby interface and introduction of this OFFS is shown in figure 2-2. And the standby interface can be switched to the mode shown in figure 2-3 with the key . The image of fibers, current fusion programme, battery capacity, the inner temperature, inner humidity, the date and time are displayed on the screen.

Chapter 6 Installation and Adjustment

- a) Open the shield and check whether are there dusty or the other eye winker (such as short fiber) in the fixture.
- b) Brush clean the V-grooves in one direction with an alcohol-soaked cotton swab.
- c) Power on the OFFS, and fix the fibers following figure 6-1 and figure 2-2. The cleave length of bare fiber should be 10mm ~ 16mm, and the bare fiber should be put in the V type groove, Cladding Fiber Holder Clamp hold down the fiber. The fiber will be seen in the middle of the screen, don't overlap.

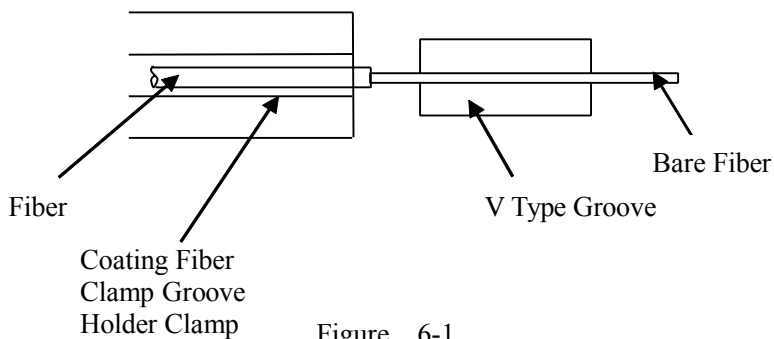



Figure 6-1

- d) Check all the key, if there were any exception, please contact us.
- e) In splice mode, use  (GAP),  (ALIGN) keys to adjust the fibers to proper positions. If the screen shows "OK", start splicing. Otherwise notice the following:
Whether the fiber is clean or not? If not, clean it.

Whether the V-groove is clean or not? If not, clean it.

Whether the fiber end profile is good or unqualified? If unqualified, cleave the fiber again.

Whether the fiber is a standard fiber or not? If not, replace it with a standard one.

If the trouble is not included in the above lists. Please ask the manufacturer for help.

- f) Press  key , the splicer accomplishes cleaning, gap adjustment, alignment, fusion splicing and loss estimating functions. The results will be displayed automatically on the screen.

Chapter 7 Basic Operation

7.1 Power Connection

Battery power and DC power were supplied to provide convenience, and the DC power was connected to the AC power through an adapter, please make sure the voltage of AC power is 110V- 240V! When the Fusion was connecting the DC power, the battery was charged.

7.2 Splicing Parameter Setting



Turn on the power and then the instrument begin self-checking. If everything was ready, splice mode would be entered, the display on the screen is as figure 2-2.

7.2.1 Main Menu

Enter The Main Menu

In the splice mode, press the  key and the instrument will enter the menu mode. The screen displays the main menu as figure 7-1.

Functions in the Main Menu

The symbol is a highlight rectangle which can be moved up or down by  or  key. Functions in the main menu are as follows:

“Fiber Type”: To select fiber type.

“Para. Group”: Select the discharge condition group, adjust the discharge parameters.

“Heat Time”: Adjust heating time.

“Splice mode”: Auto, semiauto, manual.

“Setup”: Include CMOS setting, language selection, time setup, tension test setting, and power save, restore factory settings.

“Test”: Arc Power, Overlap Test, Bright Setup, Motor Adjust.

“Maintenance”: Display the splice results or number of discharges in the memory and clear the pole.

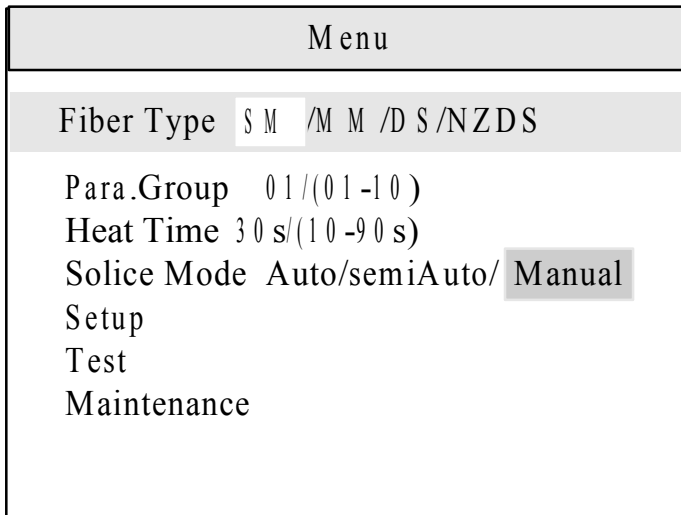



Figure 7-1

Return

In the main menu, if the  key was pressed, the splice mode would be returned to fusion mode.

7.2.2 Enter into the parameter adjustment sub-menu

After the main menu was entered, the fiber type option could be

get by  or .

The menu as following:

SM: To save single-mode fiber splicing parameter groups.

10 groups in total: 01~ 09 which can be changed.

MM: To save multi-mode fiber splicing parameter groups.

10 groups in total: 01~ 09 which can be changed.

DS: To save dispersion shift fiber splicing parameter groups.









10 groups in total: 01~ 09 which can be changed.

NZDS: To save nonzero dispersion shift fiber splicing parameter groups. 10 groups in total: 01~ 09 which can be changed.

Para. Group: The current fusion splice parameters group.

7.2.3 Switch between Splice Parameter Groups

We give an example on how to select the SM1 splice parameter group to clean the electrodes below.

- a) As the screen in figure 7-1, move the cursor to Fiber type option with  key or  key, and select "SM" with  or .
- b) Move the cursor to "Para. Group" with  key or key, and select "01" by press  key or  key.
- c) Press  to back, and all are OK.

7.2.4 Adjustment of Splice Parameters

Entering modification menu

If the parameters in SM0 group need to be adjusted, please select the "Fiber Type" option or "Para. Group", and press



to enter menu of adjustment of splice parameters.

Specification of Splice Parameters

All items in the parameters group as table 7-1.

Parameter Modification:





- a) Use the  or  key to move the cursor to the item that needs to be adjusted, and then it means this parameter could be modified.
- b) Then adjust the parameter to the ideal value with  or  key.
- c) The other parameters can be modified in the same way.

Table 7-1

Item	Range	Unit	Default Value
Prefuse Time	00~99	10ms	05
Fuse Time	00~99	100ms	14
Prefuse Power	00~99	0.1mA	30
Fuse Power	00~99	0.1mA	30
Overlap	00~40	2μm	07
End Angle	0.5~2.0	1.0°	2.0
GAP	00~09	2μm	04

7.3 Adjustment of Splice Power

This part gives instructions on how to achieve low splice loss in different environment conditions.

- a) The recommended parameter group is decided according to the fiber gap of arc test. The gap length: 015~025.
- b) Parameter modification in different circumstances.

Modify the pre-fusion current and the fusion current in the discharge parameter group, and make the value of arc test meet the requirements in step b, thus gaining a low loss. The parameters will reduce at a high temperature and increase at a low temperature.

7.4 Fiber Operation

- Step 1: Before splicing, thread the fiber through the optical fiber protection sleeve.
- Step 2: Remove fiber coating, and then brush the bare fiber with alcohol-soaked cotton swab. The typical bare fiber length is 20mm. The concentration of the alcohol should heavier than 905.
- Step 3: Cut the bare fiber using the cleaver. The typical value of the cleaver length is 10mm~16mm.
- Step 4: Open the shield and fiber holder clamp carefully. Set the fiber in the V-groove and the fiber holder on the holder mount. At the same time, note that the tip of the bare fiber does not touch anything. Make sure fiber is at the bottom of the V-groove. If not, reset the fiber.

Step 5: Set the other fiber in the same way. Put the shield down carefully.

Note:

a) Set the other fiber in the same way. Put the shield down carefully.

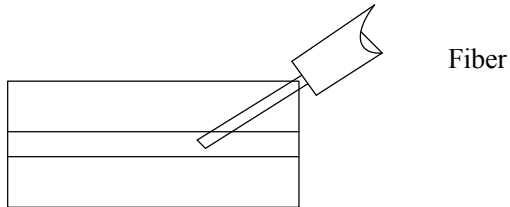

Figure 7-7 Wrong way to install

b) The tip of the coating fiber should keep a distance from the bare fiber mount.

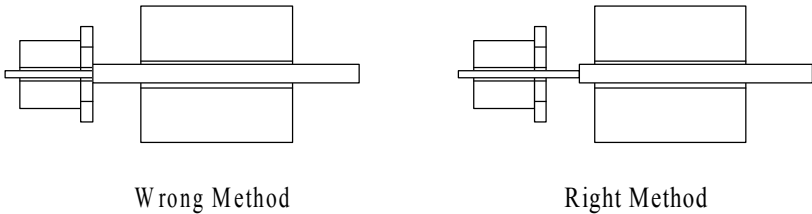

Figure 7-8

c) To be sure the coating fiber was pressed tightly by the hold clamp. The shield was closed, the fiber should be pressed on the V-groove by the shield.





7.5 Arc Power Test

Arc Power Test is very important for obtaining low splice loss. So before splicing, the test should be done. See the details in the appendix A.

7.6 Splicing Operation

There are three splicing modes for selection: Manual, Semi-auto and auto splicing mode.

7.6.1 Manual splicing mode

- (1) Strip, clean and cleave the optical fibers.
- (2) Open the shield.
- (3) Lift the fiber clamps.
- (4) Place the optical fibers in the V-grooves.
- (5) Carefully close the V-groove clamps. Ensure the bare fibers are seated at the position between the V-groove and the electrodes.
- (6) Carefully close the fiber clamps and then the shield.
- (7) Decide if the end face of fibers is good or bad.
- (8) Press the  key. The fibers move forward to their initial gap. Do gap adjustment. If either of the two end face angles is more than the preset value, an error occurs. Press the  key and prepare the fiber again.
- (9) Press  key and "ALIGN" will be displayed on the screen and the splicer will align the fibers automatically. The buzzer will beep and the screen will display "OK" after the operation is done.
- (10) Press  key to end this splicing operation. The result of estimated loss is displayed on the screen.

7.6.2 Semi-auto splicing mode

The difference between semi-auto and manual splicing mode is

whether the splicer automatically puts the two fibers end profiles to the screen center or not. We advise the user to take the auto and Semi-auto splicing mode except for special-type fiber.

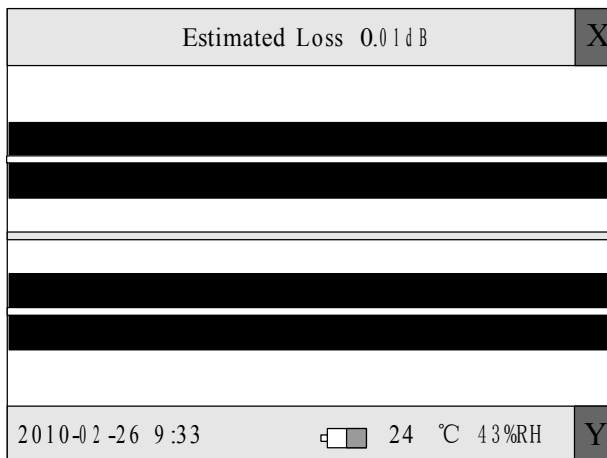

Figure 7-7

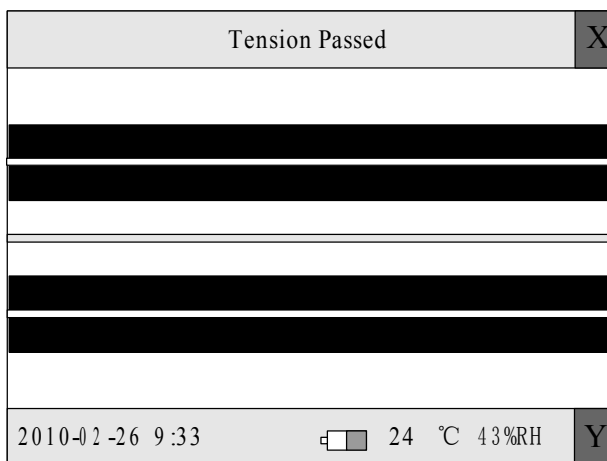

Figure 7-8

7.6.3 Auto splicing mode

"READY" is displayed on the screen.

- (1) Do the same steps as in section 7.6.1: (1), (2), (3), (4), (5), (6), (7).
- (2) Close the shield and the splicer will exercise Clean, Gap, Align, Fusion and Tension Test functions automatically. The result will be displayed on the screen as Figure 7-7 and Figure 7-8.





Notes:

1. Auto splicing mode is convenient, so we advise the user to take the auto splicing mode.
2. The splicer has the checking function of fiber cutting angle and fiber end face, when it works in Semi-auto or auto splicing mode. The quality of fiber end and face has enormous impact on the loss of the contacting point; so efforts should be mad as possible to make the end face plane, and the angle of the place with the fiber cross-sectional plane should be less than 1°.

7.7 Estimated Splice Loss

Splice loss could be estimated by observing the splicing operation and the video of the spliced part. If spliced part is abnormal (the diameter is bigger or smaller or etc.), the fiber should be re-spliced.

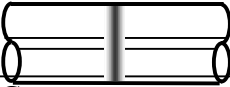
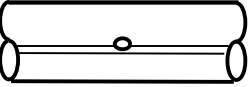
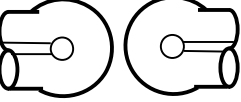
Note: When splicing different fibers or multi fiber, a black line sometimes appears on the spliced part. But it does not affect the splice result.

Phenomenon	Reason	Resolve method
Fiber Not Aligned 	Dust in the V-groove	Clean V-groove.
Fiber Diameter Too Small 	Discharge power is inappropriate.	Do Arc Power test and adjust the current.
	Splice parameter is inappropriate.	Increase discharge time or stuff length.
Black Line 	Splice parameter is inappropriate.	Adjust the current and the discharge time.
Gas 	The fiber end is unqualified.	Check cleaver.
	The current too small or discharge time too short.	Adjust the current and the discharge time.
Fiber Asunder 	The stuff length is too small.	Do an overlap test.
	The current is too strong	Reduce the current value and the discharge time.
Fiber Diameter too big 	The stuff length is too big.	Do a overlap test.
	The current is too strong or the discharge time too long.	Adjust the current value and the discharge time.

7.8 Heater Operation

- (1) Open the heater cover and the left and right fiber clamps of heater.
- (2) Move the protection sleeve to the center of the splice part.
- (3) Hold the fiber, tighten it lightly and then set the splice point in the center of the heater.

(Do not let the fiber sag)

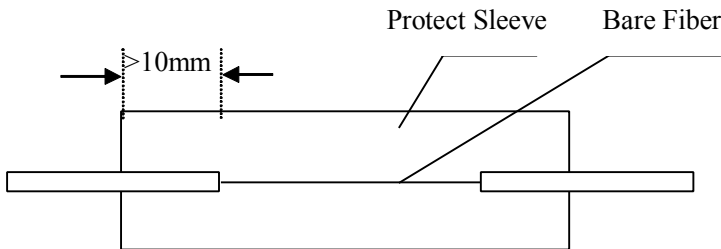

Figure 7-8

Chapter 8 Maintenance

8.1 Cleaning

Keep the V-groove, electrode, microscope clean. The shield should be closed when the splicer is not used.

8.1.1 Cleaning V-groove

If there is dust on the V-groove, the bare fiber alignment operation may produce a big splice loss. Clean the V-groove in the following steps.

- (1) Open the shield.
- (2) Cleave a bare fiber and push the tip of this fiber from the V-groove's one end to the other end.
- (3) If the above method cannot clean the V-groove, you can use an alcohol-soaked cotton swab to brush the groove to get rid of the dust.

8.1.2 Cleaning Electrodes

- (1) If the electrodes are polluted because of long-term use, wipe the tip of electrodes lightly with a cotton stick dipped in acetone or a 3 mm wide and 50 mm long grinding paper. Pay attention to protecting the electrodes' tip and its position during cleaning. Finally stabilize electrodes, see **Clear and Stabilize Electrodes** (Section D.4) for detail.
- (2) Replacing electrodes is a complex technical job, which can only be done by the manufacturer when the splicer is sent back for an overhauling.

8.1.3 Cleaning the Objective Lens

The surface of the objective lens must be kept clean. Dust on

lens can cause trouble in the image process and a big splice loss.

- (1) Turn off the power.
- (2) Use a cotton swap soaked with pure alcohol to clean the lens's surface from center toward rim.
- (3) Turn on power. Make sure dust cannot be seen on the LCD screen.

8.2 Cautions

- (1) The splicer is designed for optical telecommunication fibers. Don't insert any other type of object in the fiber clamps or arc center.
- (2) Make sure the main body of the splicer is grounded during use.
- (3) During discharge, there is a high voltage of several thousand voltages between the electrodes. So don't touch them. If there are drops of water on the splice's main body, dry it thoroughly before use.
- (4) When alcohol drops (including hand grease etc) are adhered to the electrodes, accidental discharge might occur. However, after discharging several times, such liquids will disappear and normal discharge will proceed.
- (5) Do not use the splicer in the environment full of combustibles (e.g. FREON etc). Otherwise bad splice or accidents might happen.
- (6) Never use any type of solvent other than pure alcohol when cleaning parts of the machine or fibers. When

wiping the lens with cotton stick (having been dipped in alcohol), move it in one direction instead of back and forth.

- (7) Keep the LCD screen away from the sun and high heat sources.
- (8) Turn off the power switch before power cable is connected.
- (9) The period between two consecutive power-on operations should be longer than 30 seconds.

8.3 Transportation and Storage

- (1) Always use the carrying case of the fusion splicer to prevent moisture, vibration and impact when storing and transporting the splicer.
- (2) Never store the splicer in a place where the humidity or temperature cannot meet requirements.

8.4 Alarm indication and abnormal remedy

Table 8.1

Message	Reason and Remedy
OVER RUN	There is dust on the V-groove... A fiber is detached from its V-groove. A fiber is dirty.
NO FIBER	The bare fiber is too short... Incorrect position.
L/R MOTOR OVER	A motor exceeding the limit position, causing auto reset.
FAILURE	Arc power is too strong or Arc is unstable. The gap is too big. Stuff length too small or no stuff at all
BAD	Splice parameters are inappropriate or arc power is unstable. Dust on fiber end profiles. The angle of fiber end profile is too big.
UNSTABLE ARC	The interval between two fusion is too short . Electrodes need cleaning.
NO ARC	Electrodes are dirty. Worn-out electrodes. Clean or replace electrodes
L/R -END BAD	Left or right fiber end profile is too bad; cleave fiber again.

APPENDIX A Test and Adjustment

A.1 Entering Sub-menu

Follow the instruction of section 7.4, locate two fibers with qualified end profiles before operation and close the shield.

Select "Test" item in main menu and press the  key to display the test menu on the screen.

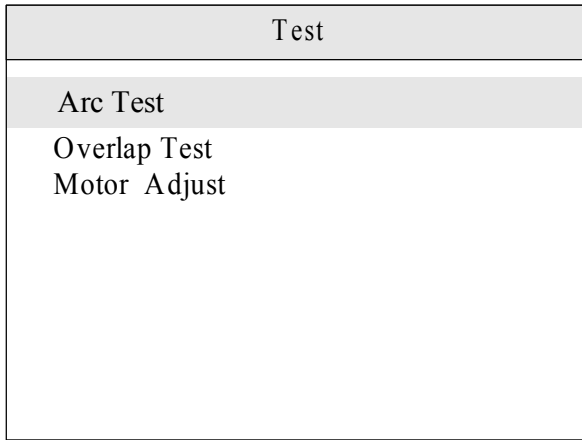



Figure A.1

Arc Test: Test the position relationship between the electrodes and fiber to decide if the fiber ends are at the center of the arc. And test whether the arc power is suitable for fiber splicing or not.

Overlap Test: Test the stuff length of the fiber during fusion splicing.

Motor Adjust: Adjust the original location of motor with the bare fiber clamped on the stage.

A.2 Arc Test

Select "Arc Test" item in the menu and press the  key to confirm.

Now the screen displays as Figure A-2.

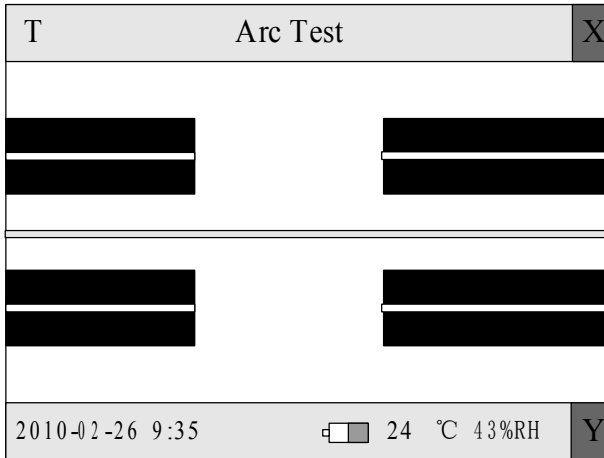



Figure A-2

Then start the Arc Test by pressing the  key. The process is as follows:

- a. The splicer puts the two fibers end profiles to the screen center automatically and accomplishes gap setting and aligning.
- b. An electrical arc is produced by electrodes. Two fiber end profiles are fused into ball shape.
- c. The location of electrodes can be calculated according to the change of fiber's shape, and displays the following information.

If the electrode's position is on the left, the screen displays " Gap XXX To R XXX ".

If the electrode's position is to the right, the screen displays "Gap XXX To L XXX".

If the electrode's deviation is within 10, no adjustment is needed. The electrodes location adjustment requires high skill. It should be done by a technician. If the value of "GAP" is between 15 and 25, the arc power is suitable for fiber splicing. If the value of "GAP" is less than this range, please increase "Prefuse Power" and "Fuse Power", contrarily, decrease "Prefuse Power" and "Fuse Power". Press the  key to return to the former operation after the test is done.

Before the Arc Power test, the electrodes should be cleaned. The test is effective only after the arc becomes stable.

A.3 Overlap Test

Choose the "Overlap Test" item in test menu and press  key to confirm. Now the screen displays as Figure A-3.

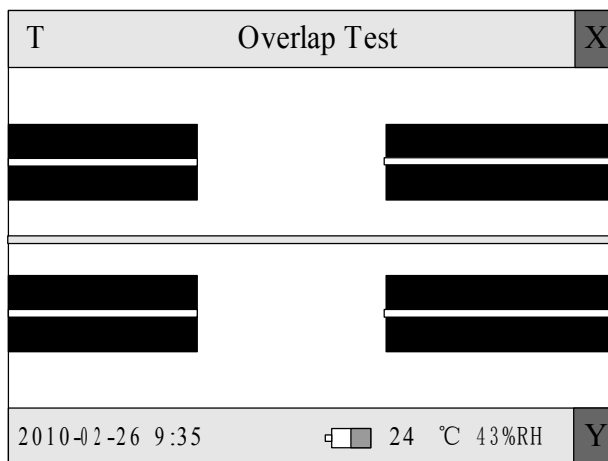



Figure A-3

- a. Send the two end profiles of fibers to the center of the screen automatically, and accomplish gap setting.
- b. The left fiber exits from the screen, but the right fiber goes

forward by "Stuff" value.





- c. The amount of stuff is calculated and displayed.



The stuff length of the fiber is set by the customer according to the arc power, fiber type and material. When it needs to be changed, follow the adjustment method of discharge parameters. Press the  key to return after the test is done.

A.4 Adjustment of Motor

Fiber Fusion Splicer has a function to check the initial positions of the left and right motor automatically. If the location is wrong during self-test, the splicer will switch to motor adjustment mode automatically. Only after the location of motor is adjusted can the splicer do fusion splicing. Otherwise, when the position of coated fiber clamp is found straying from the center obviously, i.e. it is shorter or longer when the fiber stripping length should be 16 mm. We can enter into the motor adjustment through the menu to adjust the original location of the left and right motor. The operation processes under these two conditions are as follows:

Use the Menu to Adjust

- a. Locate the 16 mm stripping length fiber properly and close the shield.
- b. Enter the test sub-menu, choose the "Motor Adjust" item and press the  key. The splicer will enter motor adjustment status. The screen displays as shown in Fig A-4.
- c. Use the ,  and  key to adjust motor's location until the fiber is displayed on the screen.

- d. Press  key so that the buzzer beeps to indicate the new location of the motor is accepted automatically by the splicer. This way the adjustment is done.
- e. Press  key to return.

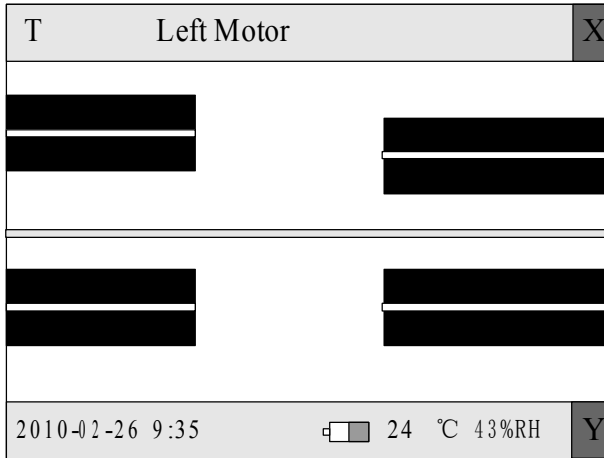



Figure A-4



Note:

If the left and right motors are close to the V-grooves, the two 16 mm stripping-length fibers may collide or one of them occupies the whole screen. In this case, the fibers could be located after the splicer enters the motor-adjustment status. The motors can be adjusted one after another.





If the grounding condition is good and the  key is pressed before the instrument is turned off, the position of motors will need no adjustment for quite a long time.

APPENDIX B Heat Time Adjustment

B.1 Functions

The splicer has 9 types of heat time for customers to select. Heat time can be set by menu. When a heat-shrink sleeve needs heating, press the  key and the heat oven will turn on/off (the indication light on/off) automatically for a length of set time. When the light is on, the  key is void. There are no influences on other functions when the heater is in work.

B.2 Adjustment

Select the "Heat Time" item in main menu and press the  key to confirm. Use the  or  key to re-select the heat time. Press the  key to return to the former menu; or press the  key to return to the "READY" status. The set-time will not be lost even if the power turns off.

APPENDIX C Setup

The function of "Setup" includes COMS sensor, Language, Date and Time, Tension, Power Save and Restore Factory Settings. Select "Setup" item in main menu and press the  key to confirm. The screen displays as shown in Figure C-1.

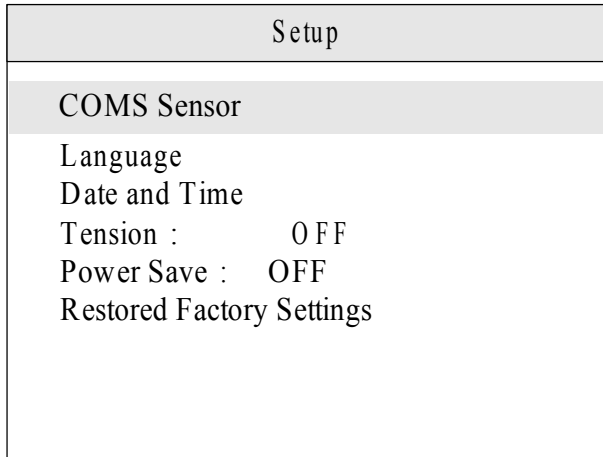











Figure C-1

C.1 Language

Use the  or  key to move the cursor to "Language", and press the  key to enter. Use the  or  key to move the cursor to the item which you want, and press the  key to return to the former menu; or press the  key to return to the "READY" status.

C.2 Date and Time

Use the  or  key to move the cursor to “Time Setting”, and press the  key to enter, the screen displays as shown in Figure C-2

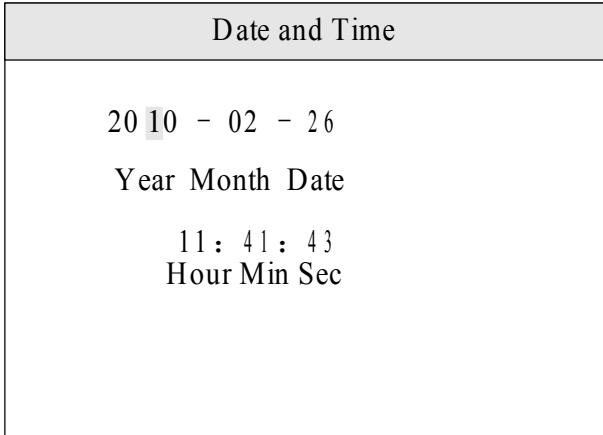











Figure C-2

Set time in the following steps:





1. Use the  or  key to move the cursor to the item which you want to change,
2. Use the  or  key to modify the number
3. After the date and time are calibrated, new time will be remembered. Press the  key to return. or press the  key to return to the "READY" status.

C.3 Tension

If the function of “Tension” is set to “ON”, a proof-test (about 2N) of the Splice point is performed automatically upon completion of fusion splicing. Set the function of “Tension” in the following steps:

1. Use the  or  key to move the cursor to “Tension”,
2. Use the  or  key to switch between different mode.

C.4 Power Save

The splicer will be shut down certain duration of time (about 5 minutes) to save unnecessary loss of battery capacity, when it is set to power saving mode. Use the  or  key to move the cursor to “Power Save”, and then use the  or  key to switch between different mode.

C.5 Restore Factory Settings

When the instrument is produced, there are some parameters(such as Fiber Type, Para. Group, Heat Time and Fusion Mode) installed .



Restoring factory settings is set by pressing the  key twice, when the cursor is moved to “Restore Factory Settings”. When the instrument is restored factory settings, the parameters of Fiber Type is SM, Para. Group is 01, the Heat Time is 50s, the Fusion Mode is Manual, the Tension is set to “OFF”, the Power Saving is ON. The table C-1 below shows other default parameters.

Table C-1

parameter \ Value	Fiber Type			
	SM	MM	DS	NZDS
Prefuse Time	08	22	08	08
Fuse Time	14	18	14	14
Prefuse Power	30	30	30	30
Fuse Power	30	30	30	30
Overlap	07	08	09	10
End Angle	2.0	2.0	2.0	2.0
Gap	04	04	04	04

APPENDIX D Maintenance

The function of Maintenance includes Fusion Record, Export Records, Arc Count, and Clear Electrodes and stabilize Electrodes. Select "Maintenance" item in main menu and press the  key to confirm. The screen displays as shown in Figure D-1.

Maintenance		
Fusion	Record	00015
Export	Record	
Arc	Count	00020
Clear	Electrode	
Stablize	Electrode	



Fig D-1

D.1 Fusion Record



The memory of the splicer can store 5000 groups of fusion splice results and discharge times. The failed and bad fusion splice results are abandoned automatically. Select the "Fusion Record " item in the sub-menu and press the  key to confirm. The splicer displays as Figure D-2.



Record NO .00012	S M 01
Pretime :	05
Fustime :	14
Prearc :	30
Fustime :	30
Overlap :	07
Angle:	1.0/0.7
Gap :	04
Loss:	0.01dB
2010-02-28	14: 25

Figure D-2

This memory can store 5000 groups of fusion splice results; the No. (Number) is 0000~4999, stored in turn. When the 5000 groups are full, the new data will cover the old ones in turn. The record time refers to the end time of each splice. The displayed sequence number is convenient for customers to inquire after any information. You can change the sequence number in turn by pressing the  or  to check all the data. Press the  key to return to the former menu.

D.2 Export Record

Select the "Export Record" item in the sub-menu and press the  key to confirm, the "Please Insert U disk" message is displayed on the screen. Press the  key to confirm again, the data will be exported to U disk. When the data is exported, the "Please pull out U disk" message is displayed on the screen. Pull out U disk, and press







the  key to return to the former menu, or press the  key to return to the "READY" status.

Notes: The format of U disk must be FAT!

D.3 Arc Count

The counter can count up to 999999. Every fusion will be taken into account, no matter the fusion splice is successful or not. Select "Maintenance" item in main menu and press the  key to confirm. The Arc Count is displayed in sub-menu.

D.4 Clear and Stabilize Electrodes

Electrodes wear with use and also must be cleaned periodically due to silica oxide buildup. It is recommended that the electrodes should be replace 2500 arc discharges. When the electrodes are replaced, it is necessary to stabilize it. Use the  or  key to move the cursor to "Clear Electrodes", and press the  key to confirm, the Electrodes will be cleaned later. In the same way, Use the  or  key to move the cursor to "Stabilize Electrodes", and press the  key to confirm, the electrodes will be stabilized.

APPENDIX E The Parameters of MMF Adjust

Enter the parameter adjust menu, select multi-mode fiber parameter. The screen displays as shown in Table.E-1.The parameters in the Table. E-1 can be as the reference.

Table. E-1

Parameters	Values
Prefuse Time	25
Fuse Time	18
Prefuse Power	22
Fuse Power	22
Overlap	07
End Angle	2.0
Gap	06

1. When splicing multi-mode fiber, gas sometimes appears on the spliced part. Increase the ‘Prefuse Time’ and reduce “Prefuse Power”, “Fuse Power”.
2. If the line on the spliced part break off, increase the ‘Fuse Time’, “Prefuse Power”, “Fuse Power”.
3. If the spliced part fiber diameter too small, reduce “Prefuse Power”, “Fuse Power”.
4. The “Fuse Power” and “Prefuse Power” must keep the same.

Note: When splicing multi fiber, a white or black line sometimes appears on the spliced part. But it does not affect the splice result.

APPENDIX F Exchange of Electrodes

1. Turn power off and unplug power cord.
2. Open the shield. The FigureF-1 shows the structure of the electrodes.
3. Removed electrode by loosening screw of the electrode holder. Insert new pair of electrodes and tighten screw alternately while pushing insulated part of the electrode.
4. Plug in the power cord, turn on the power switch, and then stabilize electrodes.

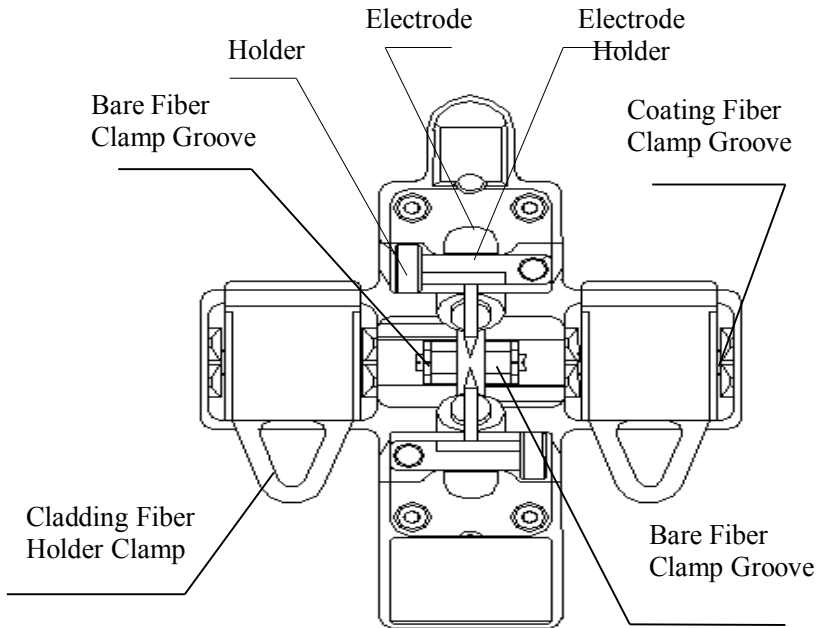



Figure F-1

APPENDIX G System Update

1. Press the  key, simultaneously, Press the  key, and then the splicer return to the "Update status, the screen displays as shown in Figure G-1.

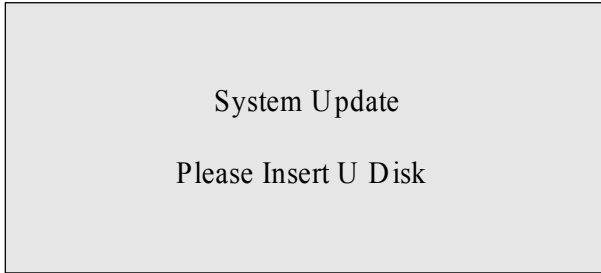

Figure G-1

2. Insert U disk with update file, the system of the splicer is update automatically. After update, the "Up update Finished. Please pull out U disk and restart." Message is displayed. If the format of U disk which is inserted the splicer is not FAT, the "Initialize failed disk not find." message is displayed on the screen; If the format of U disk without update file is FAT, the "Update failed. Check U disk or Update file." message is displayed on the screen.

When the system of the splicer is upgraded, please restart it.

Notes:

- (1) The format of U disk must be FAT, others cannot be identified.
- (2) Keep the splicer on and do not pull out U disk in the process of upgrade.
- (3) Power up the splicer again whether update is successful or not.

APPENDIX H Fiber Cleaver

H.1 General

The cleaver is a tool used for cleaving multiple and single stand optical fibers. Fiber requirements and specifications are as shown in Table H.1.

Table H.1 Specifications

<i>Fiber type:</i>	Single fiber, 250 & 900 μ m coating
<i>Clad diameter:</i>	80-125 μ m
<i>Cleave length:</i>	10mm
<i>Dimensions :</i>	70W \times 57D \times 61H, mm
<i>Weight:</i>	300 grams
<i>Typical cleave angle:</i>	1 $^{\circ}$
<i>Blade life:</i>	36,000 fiber cleaving

H.2 Operation(Refer to Figure H-1)

1. Open the bare fiber clamp.
2. Ensure the blade carrier is positioned towards the operator side.
3. Set the fiber holder into the fiber holder groove.
4. Ensure the fibers do not cross one another.
5. Close the bare fiber clamp.
6. Slide the blade carrier to score the fiber(s).
7. Press the cleaving button to cleave the fiber(s).
8. Open the bare fiber clamp.
9. Remove the fiber holder and dispose of the scrap ends.

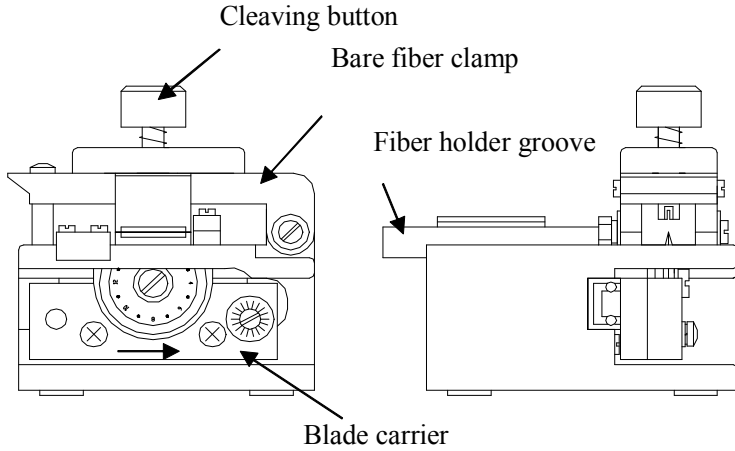

Figure H-1

H.3 Maintenance(Refer to FigureH-2)

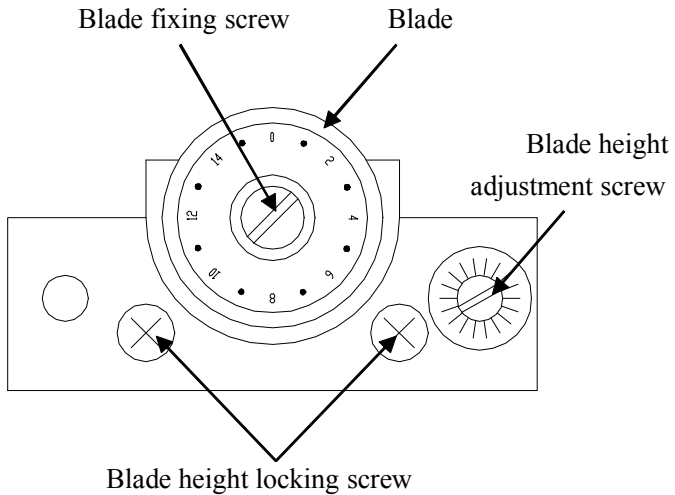

Figure H-2

If cleaving conditions become poor try the following steps.

1. Clean the upper and lower rubber surfaces of the bare fiber clamp and blade edge using a cotton swab moistened with

pure alcohol.

2. Rotate the blade position.

- Loosen the fixing screw
- Turn the blade to the next position as numbered
- Tighten the blade fixing screw

Adjusting the blade height

After all 16 blade positions have been used, the blade can then be raised to allow for additional cleaves. This height adjustment can be done twice providing a total of 48 usable blade positions. To raise the blade height.

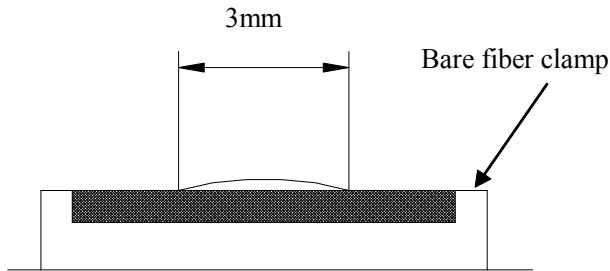

Figure H-3

- Loosen the blade height locking screws.
- Referring to FigureH-3, turn the blade height adjustment screw so that the length of exposed blade edge along the bare fiber clamp is 4 to 5mm.
- Tighten the blade height locking screws.

Blade replacement

- Remove the blade fixing screw and used blade
- Set new blade and tighten blade fixing screw

-- Contact us:

Nanjing OrientTek Optical Communication Limited

Add: RedSun Building, North Bridge Road
Nanjing, Jiangsu, China

Tel:+86-25-8687 0598 Fax:+86-25-8687 0598

Email: Sales@ORIENTEKOT.COM

Web: www.orientekot.com